

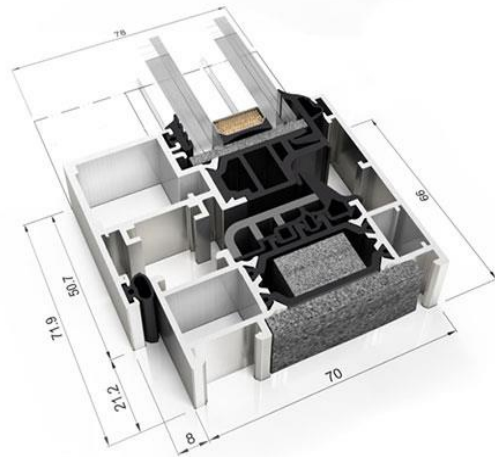

LÜMAL

EUROPEAN STANDARD

# ALUMIUM PROFILES

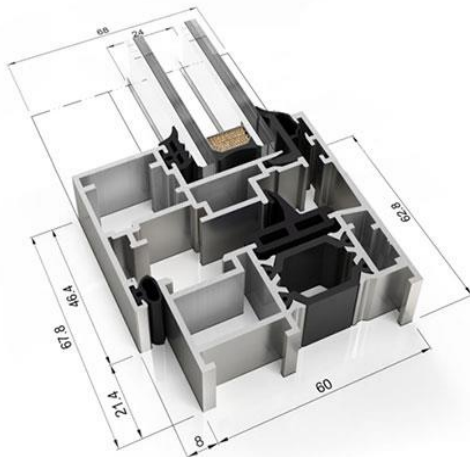



# WINDOW AND DOOR SYSTEM

## L55W, L55D – Without thermal break

EUROPEAN STANDARD

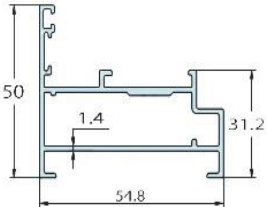
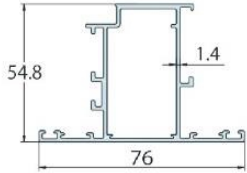
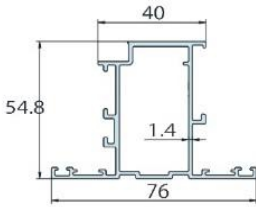
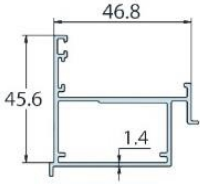
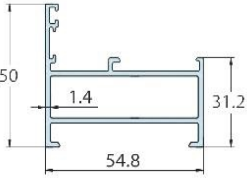
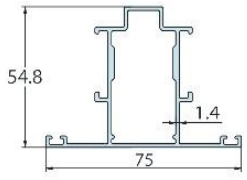
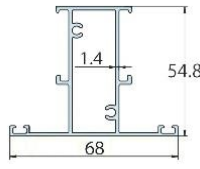
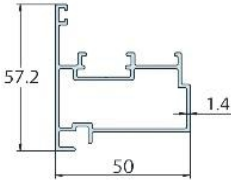
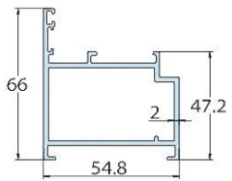
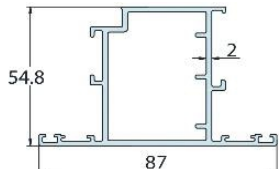
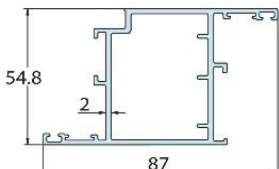
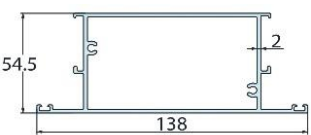
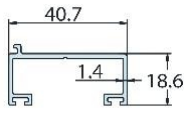
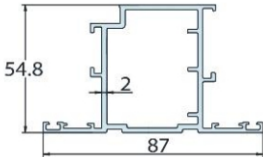
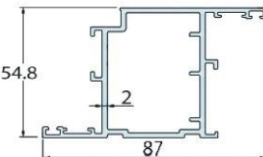
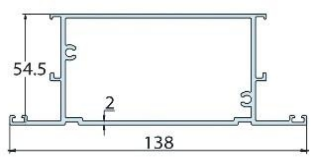
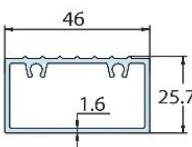
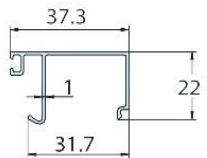
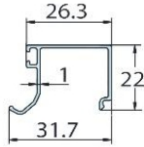
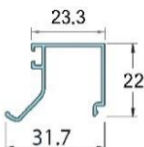
<p><b>L3318</b>   Thk: 1.4mm - W: 0.847kg/m</p> 	<p><b>L3202P</b>   Thk: 1.4mm - W: 1.09kg/m</p> 	<p><b>L3202</b>   Thk: 1.4mm - W: 1.09kg/m</p> 	<p><b>L3208</b>   Thk: 1.4mm - W: 0.76kg/m</p> 
<p><b>K3209</b>   Thk: 1.4mm - W: 0.847kg/m</p> 	<p><b>K3313</b>   Thk: 1.4mm - W: 1.013kg/m</p> 	<p><b>K3203</b>   Thk: 1.4mm - W: 0.955kg/m</p> 	<p><b>K22903</b>   Thk: 1.4mm - W: 0.889kg/m</p> 
<p><b>L3328</b>   Thk: 2mm - W: 1.23kg/m</p> 	<p><b>L3303P</b>   Thk: 2mm - W: 1.44kg/m</p> 	<p><b>L3332P</b>   Thk: 2mm - W: 1.44kg/m</p> 	<p><b>L3304P</b>   Thk: 2mm - W: 2.04kg/m</p> 
<p><b>L3329</b>   Thk: 1.4mm - W: 0.378kg/m</p> 	<p><b>L3303</b>   Thk: 2mm - W: 1.44kg/m</p> 	<p><b>L3332</b>   Thk: 2mm - W: 1.44kg/m</p> 	<p><b>L3304</b>   Thk: 2mm - W: 2.04kg/m</p> 
<p><b>L3319</b>   Thk: 1.6mm - W: 0.692kg/m</p> 	<p><b>L3295</b>   Thk: 1mm - W: 0.271kg/m</p> 	<p><b>L3236</b>   Thk: 1mm - W: 0.228kg/m</p> 	<p><b>L3286</b>   Thk: 1mm - W: 0.22kg/m</p> 



# WINDOW AND DOOR SYSTEM

L55W, L55D – Without thermal break

EUROPEAN STANDARD

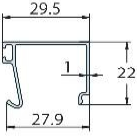
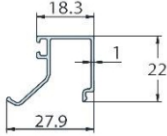
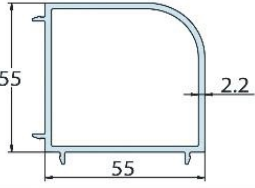
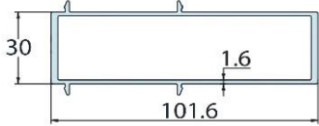
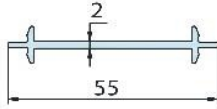
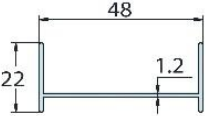
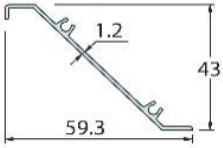
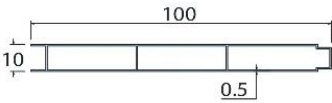
<p><b>L3296</b>   Thk: 1mm - W: 0.235kg/m</p> 	<p><b>L3225</b>   Thk: 1mm - W: 0.212kg/m</p> 		
<p><b>L3326</b>   Thk: 2mm - W: 1.182kg/m</p> 	<p><b>L3310</b>   Thk: 1.6mm - W: 1.243kg/m</p> 	<p><b>L3300</b>   Thk: 2mm - W: 0.384kg/m</p> 	
<p><b>L1283</b>   Thk: 1.2mm - W: 0.293kg/m</p> 	<p><b>L192</b>   Thk: 1.2mm - W: 0.318kg/m</p> 	<p><b>L5520</b>   Thk: 0.5mm - W: 0.345kg/m</p> 	



EUROPEAN STANDARD

# WINDOW AND DOOR SYSTEM

## L56W, L56D – With thermal break

**L5601A** | Thk: 1.5mm - W: 0.929kg/m

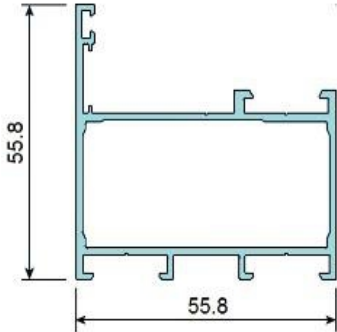

**L5604** | Thk: 1.5mm - W: 1.096kg/m

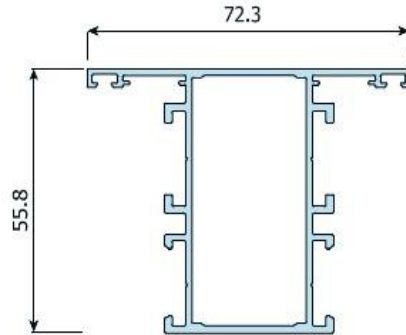

**L5606** | Thk: 1.4mm - W: 0.743kg/m

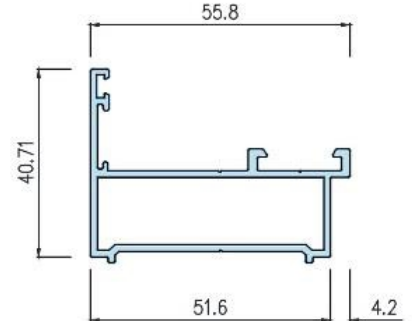

**L6907** | Thk: 1mm - W: 0.226kg/m

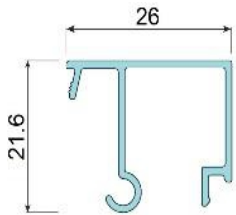

**L5608** | Thk: 1mm - W: 0.261kg/m

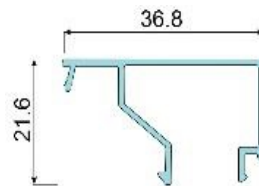

**L5613** | Thk: 2mm - W: 0.13kg/m

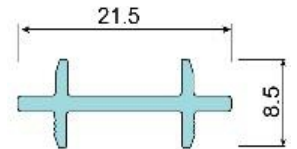

**L5601** | Thk: 2mm - W: 1.182kg/m

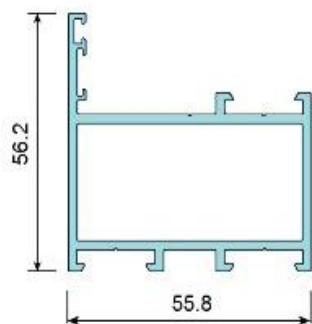

**L5602** | Thk: 2mm - W: 1.557kg/m

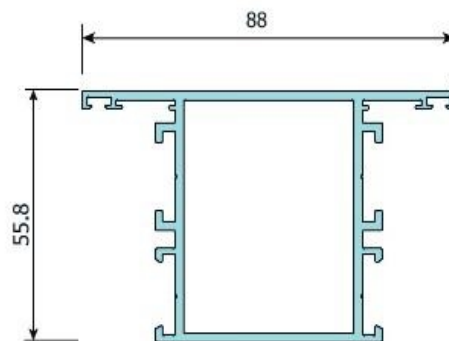

**L5603** | Thk: 2mm - W: 1.557kg/m

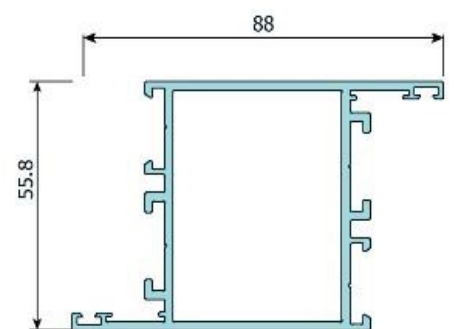

**L5607** | Thk: 2mm - W: 0.741kg/m

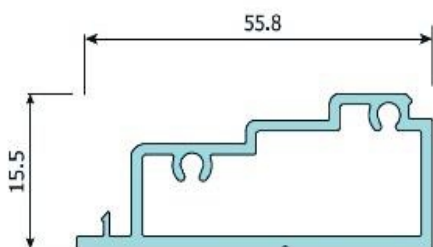

**L5605** | Thk: 2mm - W: 1.047kg/m

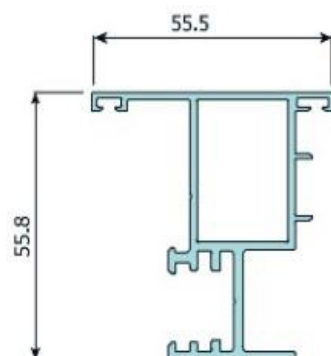





# WINDOW AND DOOR SYSTEM

## L65W, L65D – Without thermal break

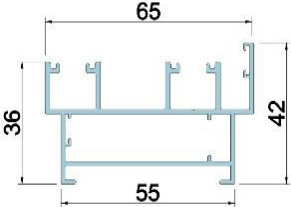
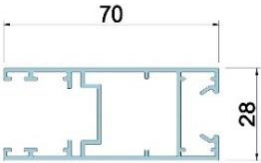
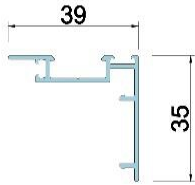
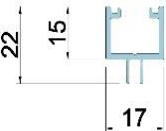
**EUROPEAN STANDARD**

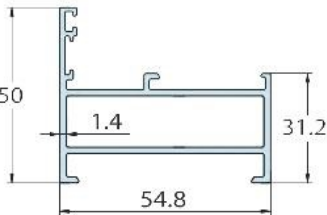
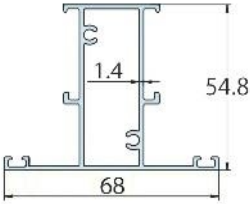
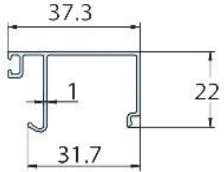
<p><b>501SW</b>   Thk: 1.2mm - W: 0.95kg/m</p> 	<p><b>L6502SW</b>   Thk: 1.2mm - W: 0.98kg/m</p> 	<p><b>L6503SW</b>   Thk: 1.2mm - W: 0.31kg/m</p> 
<p><b>408</b>   Thk: 1.4mm - W: 0.24kg/m</p> 	<p><b>L6500SW</b>   Thk: - Material: Inox 304</p> 	
<p><b>209</b>   Thk: 1.4mm - W: 0.847kg/m</p> 	<p><b>L3203</b>   Thk: 1.4mm - W: 0.955kg/m</p> 	<p><b>L3295</b>   Thk: 1mm - W: 0.271kg/m</p> 



# WINDOW AND DOOR SYSTEM

## L81SW- Without thermal break

EUROPEAN STANDARD

**L6510** | Thk: 1.5mm - W: 1.492kg/m

**L9504** | Thk: 2mm - W: 1.194kg/m

**L9505** | Thk: 1.2mm - W: 0.356kg/m

**L9507** | Thk: 1.5mm - W: 0.387kg/m

**L9508** | Thk: 1.4mm - W: 0.414kg/m

**L5611** | Thk: 1.2mm - W: 0.14kg/m

**L8803** | Thk: 1.1mm - W: 0.476kg/m

**L8805** | Thk: 1mm - W: 0.473kg/m

**L016** | Thk: 1.8mm - Material: PVC

**L5601A** | Thk: 1.5mm - W: 0.929kg/m

**L5604** | Thk: 1.5mm - W: 1.096kg/m

**L5608** | Thk: 1mm - W: 0.261kg/m



EUROPEAN STANDARD

# WINDOW AND DOOR SYSTEM

## L94SW, L94SD - Without thermal break

**L9401** | Thk: 1.4mm - W: 1.37kg/m      **L9402** | Thk: 1.6mm - W: 1.19kg/m      **L9403** | Thk: 1.6mm - W: 1.14kg/m

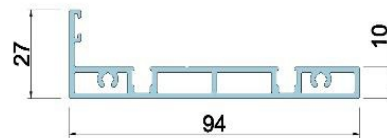
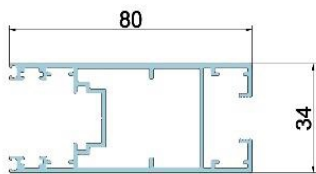
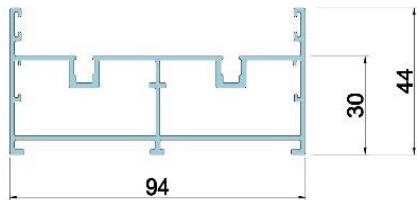

**L9406** | Thk: 1mm - W: 0.271kg/m      **L9407** | Thk: 1.4mm - W: 0.32kg/m      **L9408** | Thk: 1.4mm - W: 0.24kg/m

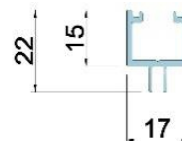
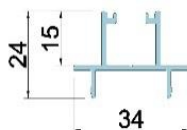
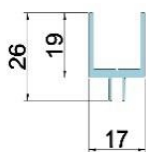

**L9405** | Thk: 1.6mm - W: 1.19kg/m      **L3203** | Thk: 1.4mm - W: 0.955kg/m      **L9404** | Thk: 1.4mm - W: 0.42kg/m

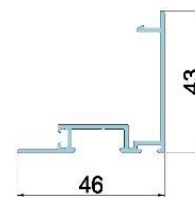
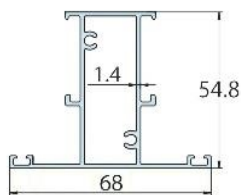
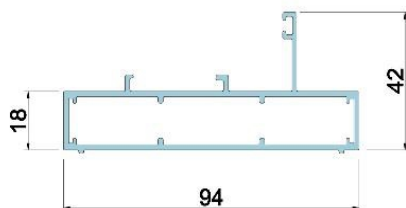

**L3295** | Thk: 1mm - W: 0.271kg/m      **L3236** | Thk: 1mm - W: 0.228kg/m      **L3286** | Thk: 1mm - W: 0.22kg/m

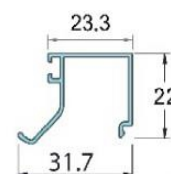
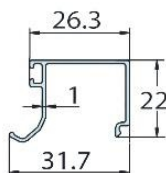
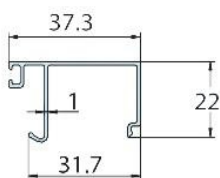





EUROPEAN STANDARD

# WINDOW AND DOOR SYSTEM

## L120SD- Without thermal break

**L12001** | Thk: 2mm - W: 2.085kg/m

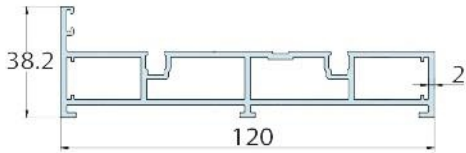

**L12004** | Thk: 2mm - W: 1.425kg/m

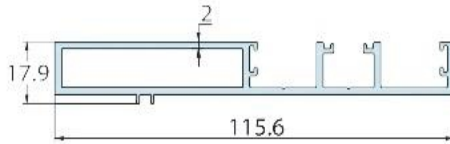

**L12005** | Thk: 2mm - W: 1.385kg/m

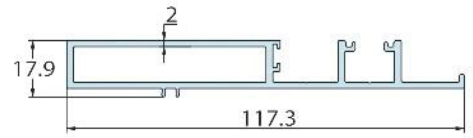

**L12002** | Thk: 2mm - W: 1.572kg/m

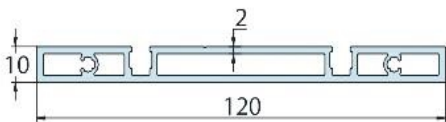

**L12006** | Thk: 2mm - W: 2.035kg/m

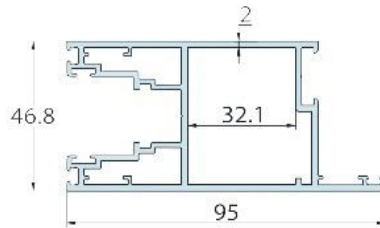

**L12003** | Thk: 2mm - W: 0.915kg/m

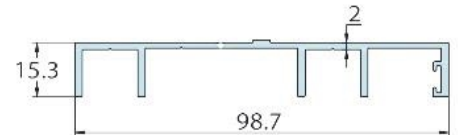

**L12007** | Thk: 1.4mm - W: 0.473kg/m

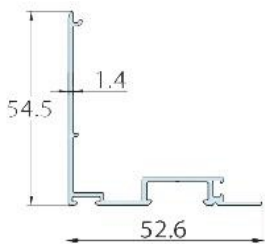

**L12008** | Thk: 2mm - W: 0.474kg/m

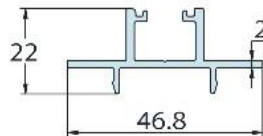

**L12011** | Thk: 1mm - W: 0.259kg/m

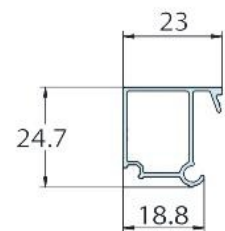

**L12009** | Thk: 2mm - W: 1.565kg/m

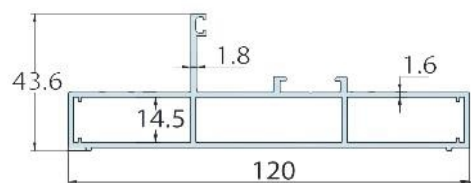

**L12010** | Thk: 2mm - W: 1.116kg/m

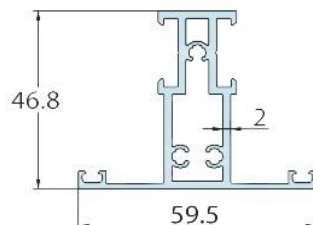

**L12012** | Thk: 1mm - W: 0.195kg/m

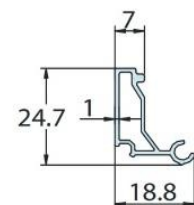



EUROPEAN STANDARD

**WINDOW AND DOOR SYSTEM**  
L69W, L69D – With thermal break

**L6901A** | Thk: 1.6mm - W: 1.383kg/m

**L6904** | Thk: 1.6mm - W: 1.541kg/m

**L6906** | Thk: 2mm - W: 1.66kg/m

**L6907** | Thk: 1mm - W: 0.226kg/m

**L5608** | Thk: 1mm - W: 0.261kg/m

**L5613** | Thk: 2mm - W: 0.13kg/m

**L6901** | Thk: 2mm - W: 1.645kg/m

**L6902** | Thk: 2mm - W: 2.15kg/m

**L6903** | Thk: 2mm - W: 2.15kg/m

**L6912** | Thk: 2mm - W: 1.101kg/m

**L6910** | Thk: 1.2mm - W: 0.181kg/m

**L6905** | Thk: 2mm - W: 1.40kg/m



EUROPEAN STANDARD

# WINDOW AND DOOR SYSTEM

## L81SB- With thermal break

**L8001** | Thk: 1.6mm - W: 1.821kg/m      **L8002** | Thk: 2mm - W: 1.403kg/m      **L8003** | Thk: 1.2mm - W: 0.342kg/m

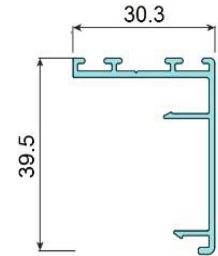
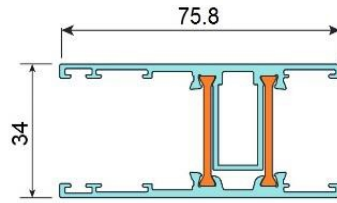
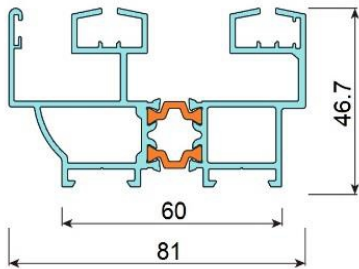

**L9507** | Thk: 1.5mm - W: 0.387kg/m      **L9508** | Thk: 1.4mm - W: 0.414kg/m      **L5611** | Thk: 1.2mm - W: 0.14kg/m

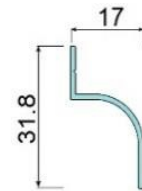
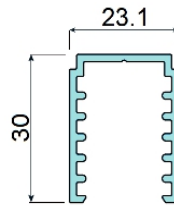
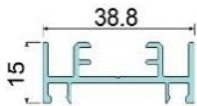

**L8803** | Thk: 1.1mm - W: 0.476kg/m      **L8805** | Thk: 1mm - W: 0.473kg/m      **L014** | Thk: 1.8mm - Material: PVC

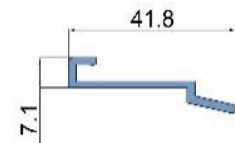
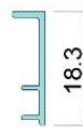
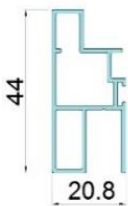

**L6901A** | Thk: 1.6mm - W: 1.383kg/m      **L6906** | Thk: 2mm - W: 1.66kg/m      **L6907** | Thk: 1mm - W: 0.226kg/m

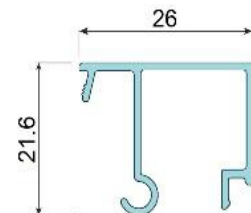
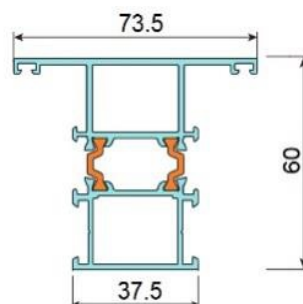
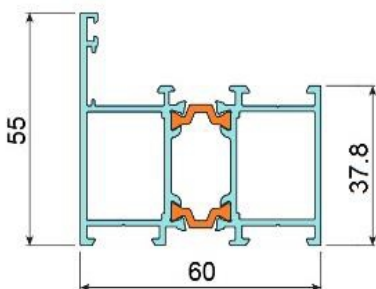



# WINDOW AND DOOR SYSTEM

## L126SB- With thermal break

EUROPEAN STANDARD



EUROPEAN STANDARD

# WINDOW AND DOOR SYSTEM

## L52S, L65S- With thermal break

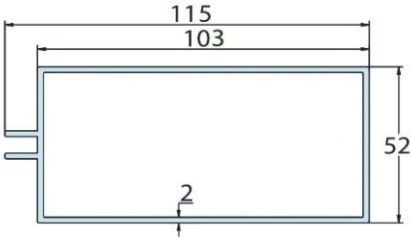
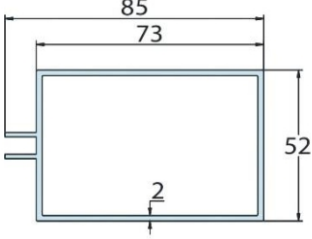
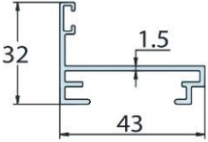
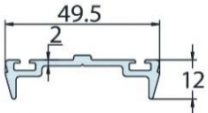
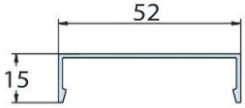
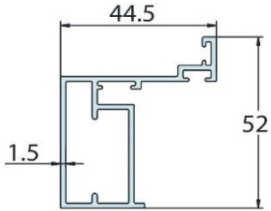
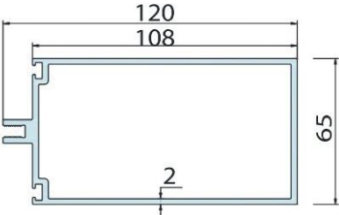
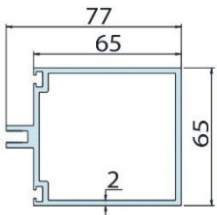
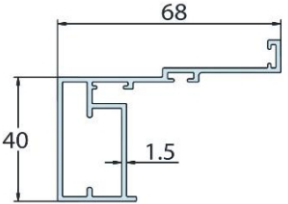
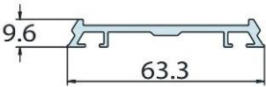
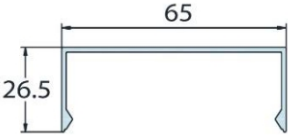
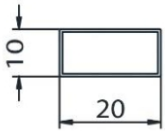
<p><b>L5201</b>   Thk: 2mm - W: 1.78kg/m</p> 	<p><b>L5202</b>   Thk: 2mm - W: 1.50kg/m</p> 	<p><b>L5205</b>   Thk: 1.5mm - W: 0.45kg/m</p> 
<p><b>L5203</b>   Thk: 2mm - W: 0.404kg/m</p> 	<p><b>L5204</b>   Thk: 1.2mm - W: 0.318kg/m</p> 	<p><b>L5206</b>   Thk: 1.5mm - W: 0.81kg/m</p> 
<p><b>L6501</b>   Thk: 2mm - W: 2.068kg/m</p> 	<p><b>L6502</b>   Thk: 2mm - W: 1.60kg/m</p> 	<p><b>L5207</b>   Thk: 1.5mm - W: 0.85kg/m</p> 
<p><b>L6503</b>   Thk: 2.3mm - W: 0.55kg/m</p> 	<p><b>L6504</b>   Thk: 1.5mm - W: 0.45kg/m</p> 	<p><b>L5200</b>   Thk: 0.6mm - W: 0.11kg/m</p> 

# WINDOW AND DOOR SYSTEM

## L93 – Without thermal break

EUROPEAN STANDARD

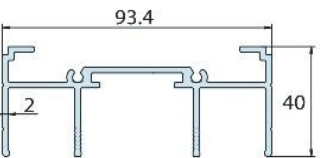
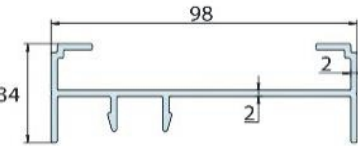
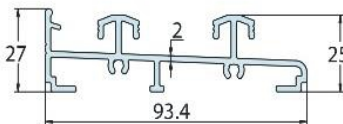
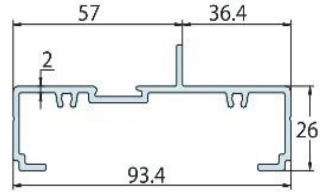
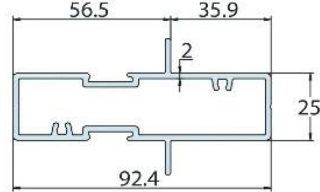
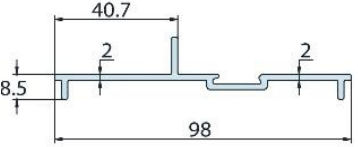
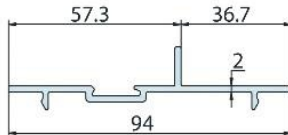
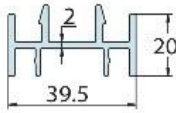
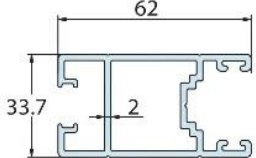
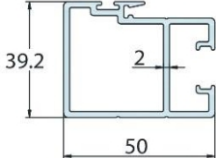
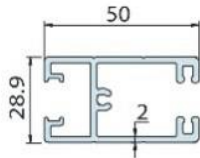
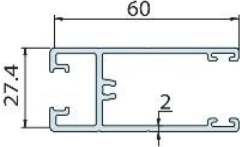
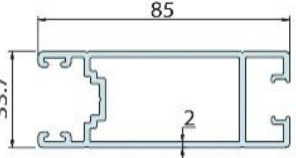
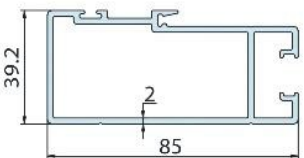
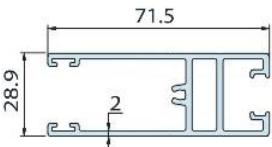
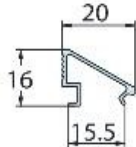
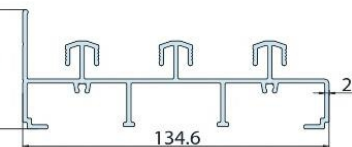
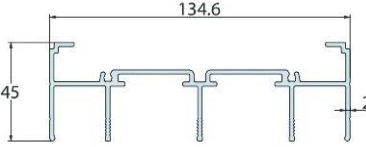
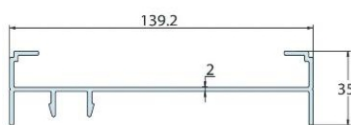
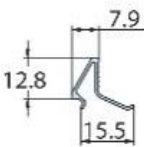
<p><b>1541</b>   Thk: 2mm - W: 1.464kg/m</p> 	<p><b>L1543</b>   Thk: 2mm - W: 1.137kg/m</p> 	<p><b>L1942</b>   Thk: 2mm - W: 1.291kg/m</p> 	<p><b>L1559</b>   Thk: 2mm - W: 1.074kg/m</p> 
<p><b>2618</b>   Thk: 2mm - W: 1.551kg/m</p> 	<p><b>L1549</b>   Thk: 2mm - W: 0.683kg/m</p> 	<p><b>L1578</b>   Thk: 2mm - W: 0.678kg/m</p> 	<p><b>L1548</b>   Thk: 2mm - W: 0.622kg/m</p> 
<p><b>1546</b>   Thk: 2mm - W: 1.227kg/m</p> 	<p><b>L1547</b>   Thk: 2mm - W: 1.111kg/m</p> 	<p><b>L1544</b>   Thk: 2mm - W: 0.994kg/m</p> 	<p><b>L1545</b>   Thk: 2mm - W: 1kg/m</p> 
<p><b>26146</b>   Thk: 2mm - W: 1.526kg/m</p> 	<p><b>L28127</b>   Thk: 2mm - W: 1.499kg/m</p> 	<p><b>L1555</b>   Thk: 2mm - W: 1.227kg/m</p> 	<p><b>L101</b>   Thk: 1mm - W: 0.133kg/m</p> 
<p><b>3212</b>   Thk: 2mm - W: 2.215kg/m</p> 	<p><b>L3211</b>   Thk: 2mm - W: 1.873kg/m</p> 	<p><b>L3213</b>   Thk: 2mm - W: 1.307kg/m</p> 	<p><b>L1779</b>   Thk: 1mm - W: 0.11kg/m</p> 



EUROPEAN STANDARD

# WINDOW AND DOOR SYSTEM

## L55V – Without thermal break

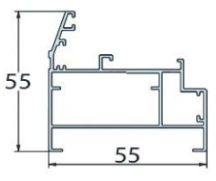
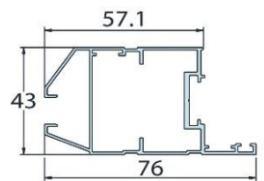
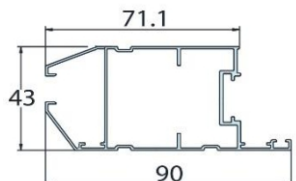
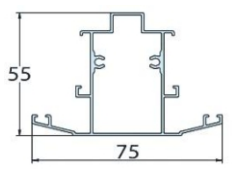
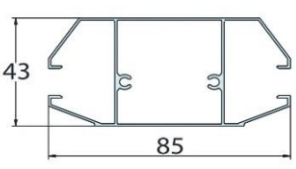
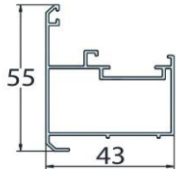
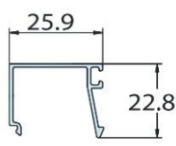
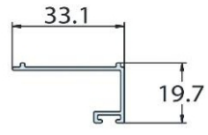
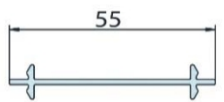
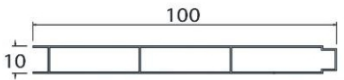
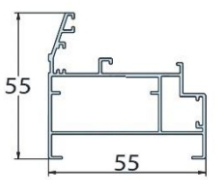
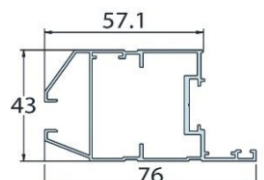
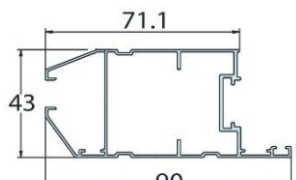
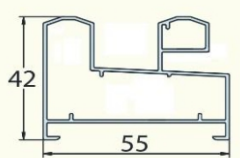
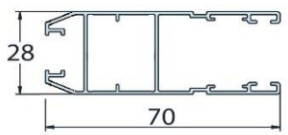
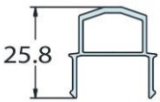
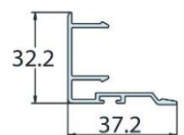
<p><b>L5501</b>   Thk: 1mm - W: 0.729kg/m</p> 	<p><b>L5504</b>   Thk: 1mm - W: 0.82kg/m</p> 	<p><b>L5512</b>   Thk: 1.1mm - W: 0.984kg/m</p> 	<p><b>L5506</b>   Thk: 1.1mm - W: 0.799kg/m</p> 
<p><b>L5513</b>   Thk: 1.1mm - W: 0.88kg/m</p> 	<p><b>L5507</b>   Thk: 1.1mm - W: 0.67kg/m</p> 	<p><b>L5511</b>   Thk: 1mm - W: 0.217kg/m</p> 	<p><b>L5533</b>   Thk: 1.1mm - W: 0.2kg/m</p> 
<p><b>L3300</b>   Thk: 2mm - W: 0.384kg/m</p> 	<p><b>L1050</b>   Thk: 0.5mm - W: 0.328kg/m</p> 		
<p><b>L5501M</b>   Thk: 0.85mm - W: 0.62kg/m</p> 	<p><b>L5504M</b>   Thk: 0.85mm - W: 0.73kg/m</p> 	<p><b>L5512M</b>   Thk: 0.85mm - W: 0.799kg/m</p> 	
<p><b>L5006</b>   Thk: 1.1mm - W: 0.736kg/m</p> 	<p><b>L5566</b>   Thk: 0.8mm - W: 0.583kg/m</p> 	<p><b>L5604</b>   Thk: 1mm - W: 0.244kg/m</p> 	<p><b>L5003</b>   Thk: 1.1mm - W: 0.276kg/m</p> 



EUROPEAN STANDARD



## Lümal Viet Nam

ADDRESS: 7/20GM, Road 4, Binh Hung, Binh Chanh, Ho Chi Minh city

PHONE NUMBERS: (+84) 388.622.522

EMAIL ADDRESS: [support@lumal.com.vn](mailto:support@lumal.com.vn)

WEBSITE: [lumal.com.vn](http://lumal.com.vn)